

ITEM	QTY	BILL OF MATERIAL
1	1	WING, 2-PRONG
2	1	WING, 3-PRONG
3	1	PIN, KNURLED

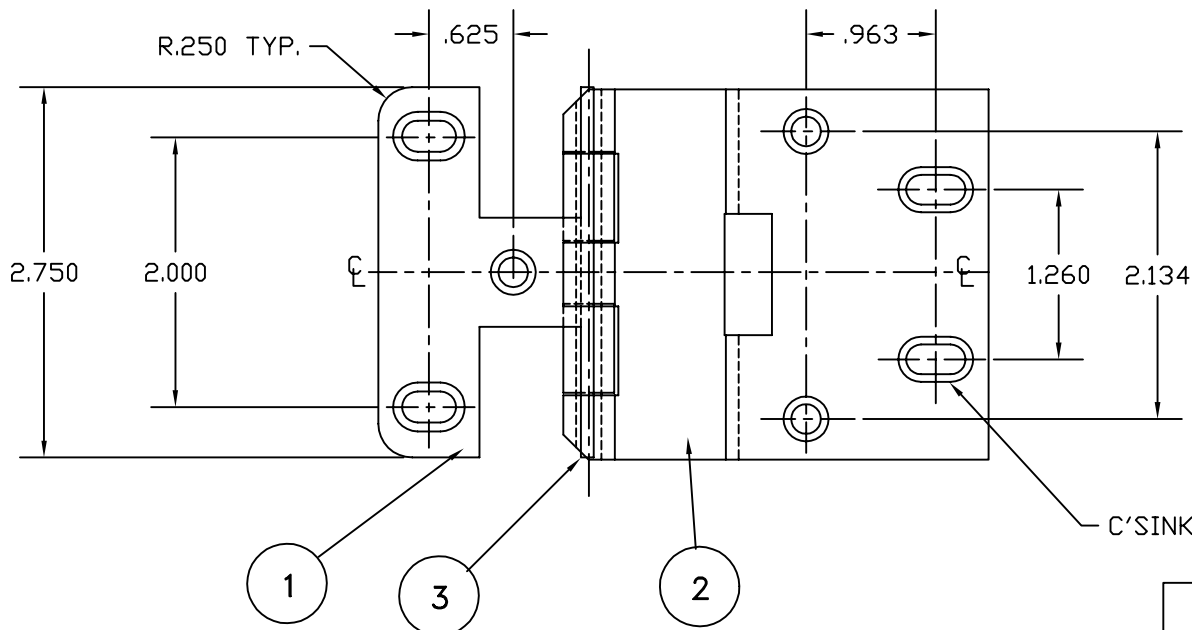

C'SINK FOR #8 FLATHEAD SCREW OR 5MM EURO SCREW (9)

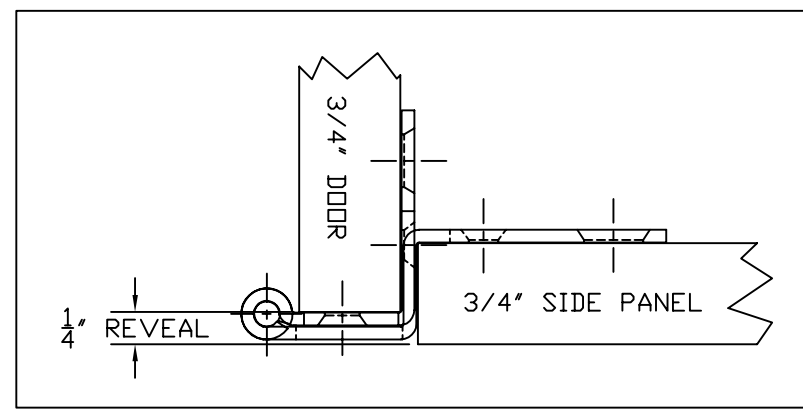
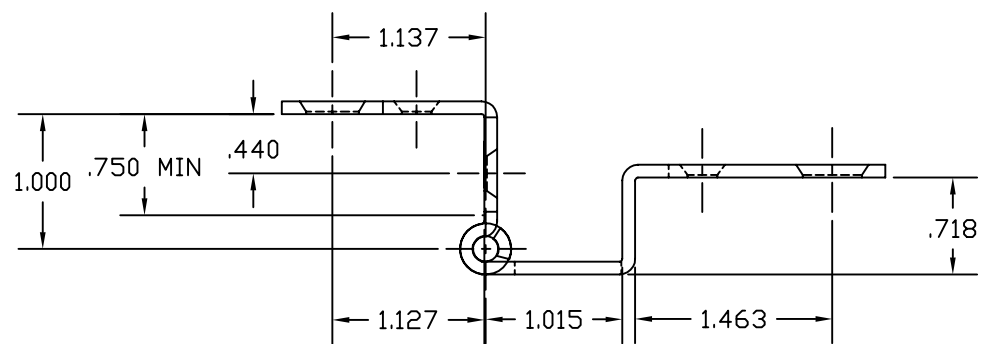

APPLICATION DRAWING

CUSTOMER P/N (IF APPLICABLE)	REV.
------------------------------	------

THIS PRINT IS THE PROPERTY OF RPC AND ITS DUPLICATION, RETENTION OR TRANSMITTAL TO OTHERS IS PROHIBITED WITHOUT PRIOR CONSENT.



ECR#	REV.	DESCRIPTION	BY	DATE

MATERIAL	SEE B.O.M.	SCALE (SIZE)	1:1.5	SHT NO.	1	OF	1
FILENAME	846APP	MAT'L WT (LBS/EA)		PART DESCRIPTION	HINGE, OVERLAY 3/4" X 3/4"		
DRAWN BY	MAB	DATE	3/18/05	PART NUMBER	846-APP	REV.	