

ITEM	QTY	BILL OF MATERIAL
1	1	WING, 2-PRONG
2	1	WING, 3-PRONG
3	1	PIN, KNURLED

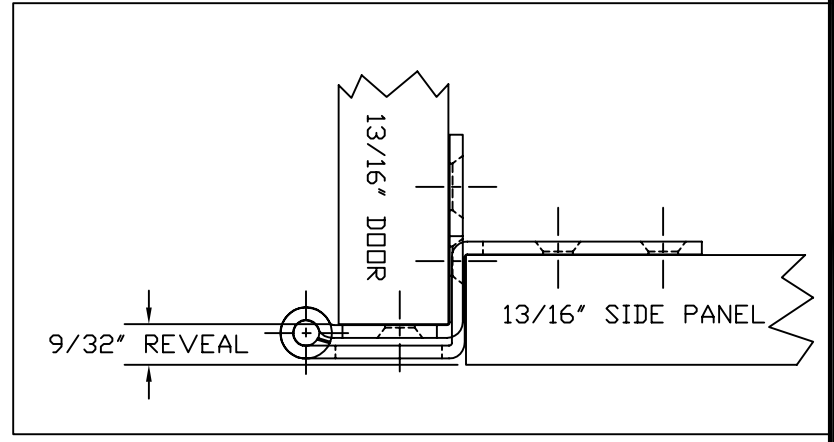
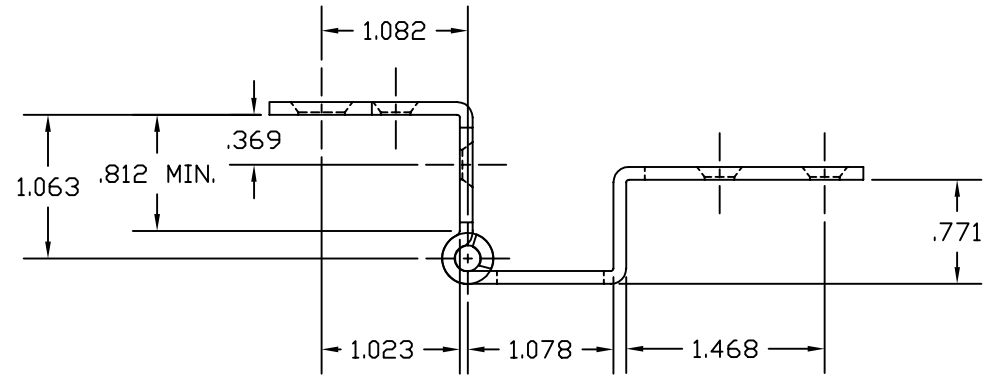
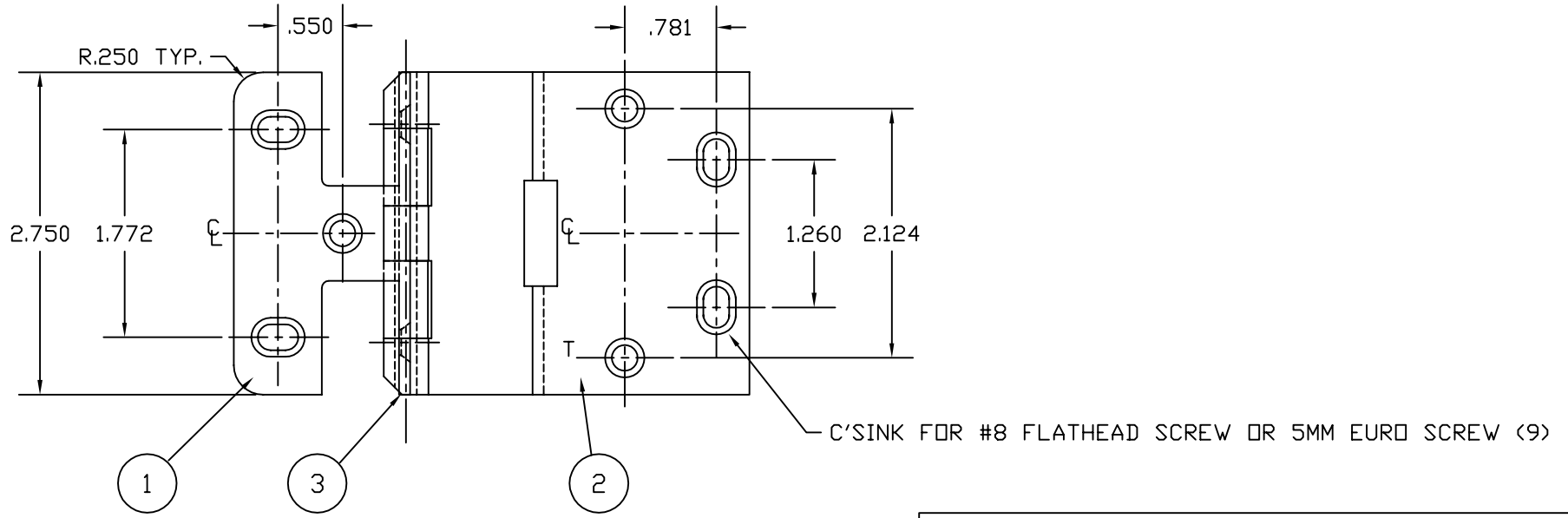

APPLICATION DRAWING

CUSTOMER P/N (IF APPLICABLE)	REV.
------------------------------	------

THIS PRINT IS THE PROPERTY OF RPC AND ITS DUPLICATION, RETENTION OR TRANSMITTAL TO OTHERS IS PROHIBITED WITHOUT PRIOR CONSENT.



ECR#	REV.	DESCRIPTION	BY	DATE

MATERIAL	SEE B.O.M.	SCALE (SIZE)	1:1.5	SHT NO.	1	OF	1
FILENAME	455APP	MAT'L WT (LBS/EA)		PART DESCRIPTION	HINGE, OVERLAY 13/16" x 13/16"		
DRAWN BY	MAB	DATE	3/16/05	PART NUMBER	455-APP	REV.	